

CATALOGUE

1 **IDEA.me**[®]
DESIGN GIFTS

The TRAVEL MAP OF THE WORLD

Black
DISCOVER THE WHOLE WORLD
SINCE 2012

1 **IDEA.me**[®]
— BY —

ENG
SCRATCH MAP OF THE WORLD
IS YOUR PERSONAL TRAVEL
DIARY THAT HAS BEEN DESIGNED
TO SHOW YOUR FAMILY AND
FRIENDS WHERE YOU HAVE TRAVELLED
THROUGH THE WORLD. IT'S
UNIQUE DESIGN HAS A GOLD TOP
FOIL LAYER. YOU SIMPLY TAKE A
COIN AND SCRATCH OFF THE FOIL
FROM PLACES YOU'VE VISITED TO
REVEAL A WHOLE NEW AND
COLOURFUL WORLD UNDERNEATH.
EAT WAY TO COMMEMORATE
TAKEN OR DREAM OF
YET TO COME!

PIÑATA
BOTSWANA BASKETS





KSENIIA FURSOVA & MYKYTA FURSOV
THE FOUNDERS OF 1DEA.me

ABOUT US

MISSION

TO INSPIRE PEOPLE OF ALL AGES ALL AROUND THE WORLD
TO DREAM, TO PLAN AND TO DO!

WIN-WIN

We create unique design gifts!
Professional Team and a desire to make each Client happy help us to create high-demand products and successfully expand the geography of our sales. Our products are sold in European and Asian countries, in South and North America and even in far-off Australia. 1DEA.me maps and posters have been highly estimated in over 100 countries. Our goal is to build long-term and win-win relations with the partners from all over the world!

DREAM PLAN DO

**TRAVEL
MAP[®]**
SCRATCH-OFF MAPS



SCRATCH-OFF
TRAVEL MAP SILVER WORLD

PLASTIC

8-9



SCRATCH-OFF
TRAVEL MAP BLACK WORLD

PLASTIC

10-11



SCRATCH-OFF
TRAVEL MAP AIR WORLD

PLASTIC

12-13



SCRATCH-OFF
TRAVEL MAP LETTERS WORLD

PAPER

14-15



SCRATCH-OFF
TRAVEL MAP GEOGRAPHY WORLD

PAPER

16-17



SCRATCH-OFF
TRAVEL MAP HOLIDAY WORLD

PAPER

18-19



SCRATCH-OFF
TRAVEL MAP HOLIDAY LAGOON
WORLD

PAPER

20-21



SCRATCH-OFF
TRAVEL MAP MARINE WORLD

PLASTIC

22-23



SCRATCH-OFF
TRAVEL MAP BLACK EUROPE

PAPER

24-25



SCRATCH-OFF
TRAVEL MAP SILVER EUROPE

PLASTIC

26-27



SCRATCH-OFF
TRAVEL MAP WEEKEND WORLD

PAPER

28-29



SCRATCH-OFF
TRAVEL MAP USA BLACK

PLASTIC

30-31



SCRATCH-OFF
TRAVEL MAP POLSKA

PAPER

32-33



SCRATCH-OFF
TRAVEL MAP BRASIL

PLASTIC

34-35



SCRATCH-OFF
TRAVEL MAP Ceská REPUBLIKA

PAPER

36-37



SCRATCH-OFF
TRAVEL MAP MAGNETIC WORLD

PLASTIC

38-39



SCRATCH-OFF
TRAVEL MAP FLAGS WORLD

PAPER

40-41



SCRATCH-OFF
TRAVEL MAP THE KIDS MAP WORLD



42-43

#100BUCKETLIST[®]
SCRATCH-OFF POSTERS



SCRATCH-OFF POSTER
#100BUCKETLIST LIFE EDITION

PAPER

46-47



SCRATCH-OFF POSTER
#100BUCKETLIST LOVE EDITION

PAPER

48-49



SCRATCH-OFF POSTER
#100BUCKETLIST KAMASUTRA
EDITION

PAPER

50-51



SCRATCH-OFF POSTER
#100BUCKETLIST JUNIOR
EDITION

PAPER

52-53



SCRATCH-OFF POSTER
#100BUCKETLIST WONDERS EDITION

PAPER

54-55



GLOWING MAP
STAR MAP OF THE SKY

PAPER

58-59



SCRATCH-OFF WALL GROWTH CHART
"SPACE ADVENTURES"

PLASTIC

60-61



SCRATCH-OFF WALL GROWTH CHART
"MAGIC ADVENTURES"

PLASTIC

62-63



The
TRAVEL MAP
OF THE
WORLD

> *Geography* <
FOR THE WHOLE WORLD
SINCE 2012

- RU
- VALU
- 6 km²
- SEYCHELLES
- 459 km²
- PRINCIPALITY OF HUTT RIVER
- 75 km²
- PRINCIPALITY OF SEALAND
- 4 km²

The
TRAVEL MAP
OF THE
WORLD

> *Geography* <
DISCOVER THE WHOLE WORLD
SINCE 2012

TRAVEL MAP® SCRATCH-OFF MAPS

CREATE YOUR OWN TRAVEL STORY!

Travel Map — scratch-off gift maps of the world, specific countries and regions. By scratching off the special layer, you can mark countries and cities that you've visited, and plan new routes. Any map of the collection will be an inspiring and motivational decor for home or office. Scratch-off Travel Maps are a best-seller in many countries in the world. The brand is loved and chosen as a present for family, friends and co-workers.

STONEHENGE
England
EASTER ISLAND
South

WONDERS

TRAVEL MAP SILVER WORLD

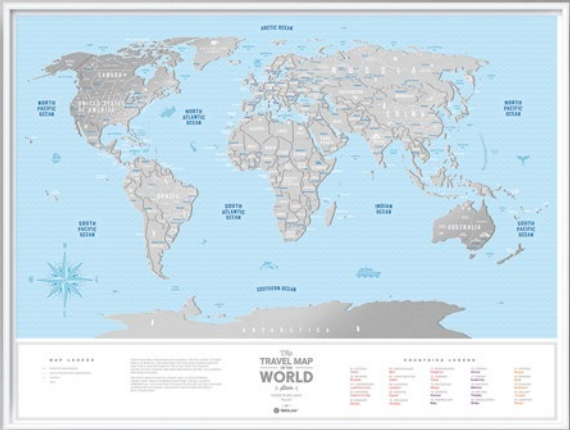

THIS UNIQUE MAP HAS BEEN DESIGNED FOR PERSONAL JOURNEYS. SCRATCH OFF THE SPECIAL LAYER FROM THE COUNTRIES YOU'VE VISITED AND CREATE YOUR OWN MEMORABLE STORY OF ADVENTURES!

ERASE THE SCRATCH-OFF LAYER AND DRAW WITH A MARKER
 MINIMALISTIC DESIGN TO MATCH ANY INTERIOR



ACCESSORY SET

- instruction
- scratcher
- marker
- felt shred
- luggage tag
- pins



SKU: SW
 EAN: 4820191130104

BEFORE



AFTER

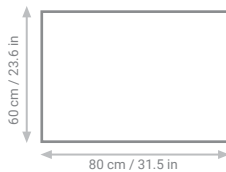

POSTER
 W 80 cm / 31.5 in
 H 60 cm / 23.6 in

PLASTIC
 ENG

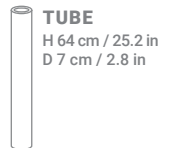

TUBE
 H 64 cm / 25.2 in
 D 7 cm / 2.8 in

TRAVEL MAP BLACK WORLD

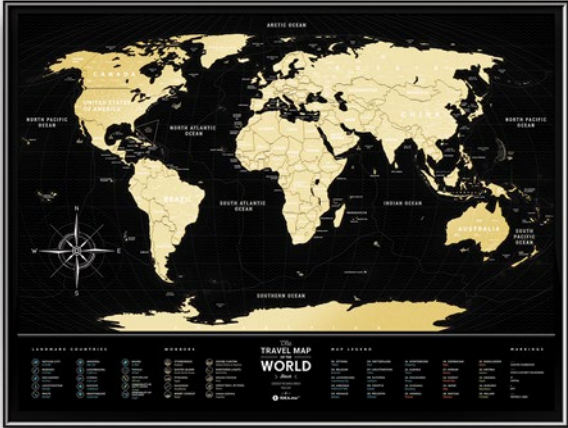

A MAP HAS BEEN DESIGNED FOR THE LOVERS OF SHOWY AND STYLISH THINGS. UNIQUE AND EXCLUSIVE MAP OF THE WORLD WITH A SPECIAL GOLDEN LAYER WILL MAKE YOUR TRAVELLING MORE COLORFUL AND VIVID.

ERASE THE SCRATCH-OFF LAYER AND DRAW WITH A MARKER
MODERN AND STYLISH DESIGN



ACCESSORY SET

- instruction
- scratcher
- white ink marker
- felt shred
- luggage tag
- pins



SKU: BW
EAN: 4820191130074

BEFORE



AFTER

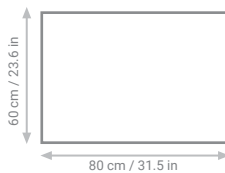

POSTER

W 80 cm / 31.5 in
H 60 cm / 23.6 in

PLASTIC

ENG

TUBE

H 64 cm / 25.2 in
D 7 cm / 2.8 in



TRAVEL MAP AIR WORLD



THIS INSPIRING TRANSPARENT SCRATCH-OFF MAP WILL BE A WONDERFUL GIFT FOR A PERSON WHO NEEDS TRAVELS LIKE THE AIR AND FOR THOSE WHO JUST HAVE STARTED TO EXPLORE OUR WONDERFUL WORLD. DUE TO ITS ORIGINAL DESIGN THE MAP MATCHES ANY INTERIOR PERFECTLY AND HAS THAT NICE AIRY LOOK. ALL COUNTRIES ARE COVERED WITH THE SILVER LAYER. AFTER ITS SCRATCHING THE MAP REVEALS ITS BRIGHT COLORS.

TRANSPARENT AND VERY DETAILED

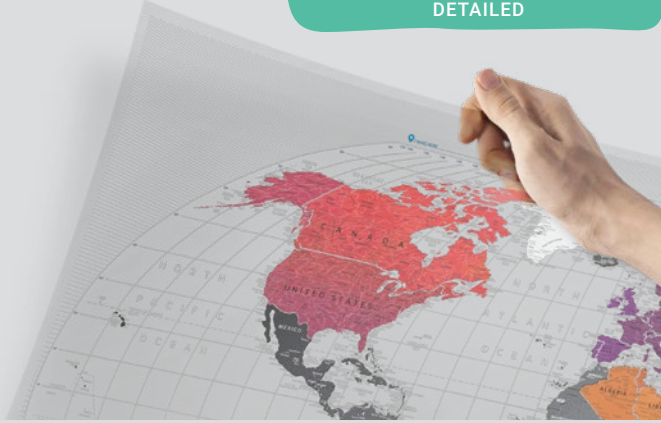

ACCESSORY SET

- instructions
- scratcher
- pins
- felt shred
- check-in stickers
- marker



SKU: AW
EAN: 4820191130418

BEFORE



AFTER

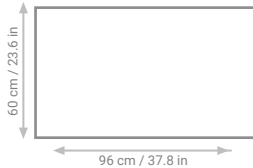

POSTER
W 96 cm / 37.8 in
H 60 cm / 23.6 in

PLASTIC
ENG

TUBE
H 64 cm / 25.2 in
D 7 cm / 2.8 in

TRAVEL MAP LETTERS WORLD



COLORFUL SCRATCH-OFF FONT MAP WITH A HISTORY OF YOUR TRAVELS, ON WHICH EACH COUNTRY IS REPRESENTED BY LETTERS. SCRATCH OFF THE SILVER LAYER FROM THE COUNTRIES YOU'VE BEEN TO, SO THE MAP BECOMES BRIGHTER, AND YOUR LIFE GETS MORE SATURATED. THIS IS A POSITIVE GIFT FOR FRIENDS AND FAMILY, WHICH INSPIRES TO DISCOVER THE WORLD FROM A TO Z.

TRENDY FONT DESIGN



ACCESSORY SET

- instruction
- scratcher
- pins
- felt shred
- stickers



SKU: LW
EAN: 4820191130425

BEFORE



AFTER

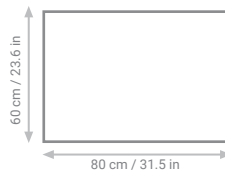

POSTER

W 80 cm / 31.5 in
H 60 cm / 23.6 in

PAPER

ENG

TUBE

H 64 cm / 25.2 in
D 7 cm / 2.8 in



TRAVEL MAP GEOGRAPHY WORLD



THIS IS THE MOST DETAILED MAP OF YOUR OWN WANDERS WHERE YOU CAN EASILY MARK THE COUNTRIES, CITIES AND ISLANDS YOU'VE VISITED. SCRATCH THE COUNTRIES WITH A HELP OF A SCRATCHER OR PIN IT AND MAKE YOUR MEMORABLE TRAIN OF JOURNEYS.

THE MOST DETAILED MAP



ACCESSORY SET

- postcard
- felt shred
- pins
- push-pins
- scratcher



SKU: GEOW
EAN: 4820191130296

BEFORE



AFTER

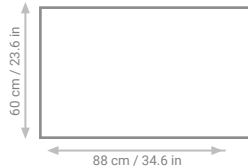

POSTER
W 88 cm / 34.6 in
H 60 cm / 23.6 in

PAPER
ENG

TUBE
H 64 cm / 25.2 in
D 7 cm / 2.8 in

TRAVEL MAP HOLIDAY WORLD



EVERY TRIP IS ALWAYS A HOLIDAY.
BRIGHT COLORS, TRAVEL MUST-HAVE THINGS AND A QUEST OF IDEAS FOR AN UNFORGETTABLE REST, AND, IN ADDITION, AN ENLARGED EUROPE WHICH WILL ADD SOME VIVID COLORS TO YOUR EUROTRIP.

MAP OF THE WORLD AND MAP OF EUROPE 2 IN 1



BEFORE



AFTER



ACCESSORY SET

- instruction



SKU: HW
EAN: 4820191130227

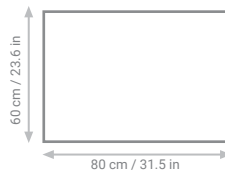

POSTER

W 80 cm / 31.5 in
H 60 cm / 23.6 in

PAPER

ENG

TUBE

H 64 cm / 25.2 in
D 7 cm / 2.8 in

TRAVEL MAP HOLIDAY LAGOON WORLD

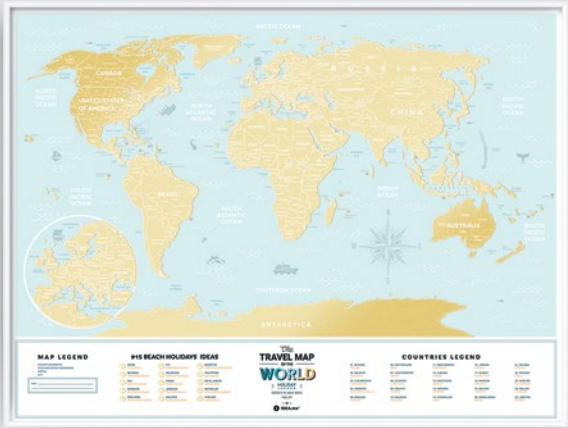

A SCRATCH-OFF MAP OF THE WORLD AND YOUR PERSONAL TRAVEL DIARY. SCRATCH OFF THE GOLDEN LAYER FROM THE PLACES YOU'VE VISITED. SIGN THE MAP WITH YOUR NAME AND USE THE CHECK-LIST OF THE WORLD'S BEST BEACHES. MARK EVEN THE SMALLEST COUNTRIES ON AN ENLARGED EUROPE.

MAP OF THE WORLD AND MAP OF EUROPE 2 IN 1



BEFORE



AFTER



ACCESSORY SET

- instruction



SKU: HLW
EAN: 4820191130524

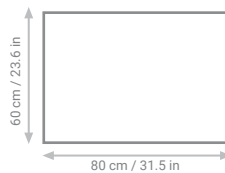

POSTER

W 80 cm / 31.5 in
H 60 cm / 23.6 in

PAPER

ENG

TUBE

H 64 cm / 25.2 in
D 7 cm / 2.8 in



IT'S A BRIGHT AUDACIOUS MAP DESIGNED IN AN UNUSUAL MARINE STYLE. TRIP PLANNING AND MARKING THE VISITED COUNTRIES IS EVEN MORE EXCITING AS DOZENS OF SEA ANIMALS WILL BE YOUR COMPANY!

MINI MAP OF THE WORLD WITH
CUSTOM ILLUSTRATIONS IN MARINE STYLE



ACCESSORY SET

- instruction
- scratcher
- marker
- felt shred
- laguage tag
- magnets
- pins



SKU: MW
EAN: 4820191130203

BEFORE



AFTER



40 cm / 15.7 in

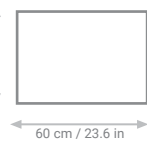

POSTER

W 60 cm / 23.6 in
H 40 cm / 15.7 in

PLASTIC
ENG



TUBE

H 45 cm / 17.7 in
D 7 cm / 2.8 in

NEW



THE MAP OF EUROPE HAS BEEN DESIGNED FOR LOVERS OF PARIS ALLEYS AND SUNSETS OF COSTA BRAVA. A CHECK-LIST OF EUROPE CAPITALS GIVES A HINT ON A GREAT NUMBER OF UNEXPLORED COUNTRIES AND TERRITORIES.

PERFECT MAP FOR THE FANS OF EUOTRIPS
WITH A CHECK-LIST OF EUROPE CAPITALS



ACCESSORY SET

- instruction
- scratcher
- felt shred
- check-in stickers
- pins



SKU: BE
EAN: 4820191130708

BEFORE



AFTER

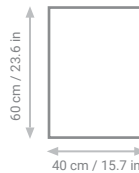

POSTER
W 40 cm / 15.7 in
H 60 cm / 23.6 in

PAPER
ENG

TUBE
H 45 cm / 17.7 in
D 7 cm / 2.8 in

TRAVEL MAP SILVER EUROPE



THE MAP OF EUROPE HAS BEEN DESIGNED FOR THE LOVERS OF PARIS ALLEYS AND SUNSETS OF COSTA BRAVA. A CHECK-LIST OF EUROPEAN CAPITALS GIVES A HINT ON A GREAT NUMBER OF UNEXPLORED COUNTRIES AND TERRITORIES.

PERFECT MAP FOR THE FANS OF EUROTRIPS
WITH A CHECK-LIST OF EUROPE CAPITALS



ACCESSORY SET

- instruction
- scratcher
- marker
- felt shred
- luggage tag
- pins



SKU: SE
EAN: 4820191130098

BEFORE



AFTER

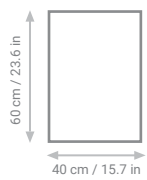

POSTER
W 40 cm / 15.7 in
H 60 cm / 23.6 in
PLASTIC
ENG

TUBE
H 45 cm / 17.7 in
D 7 cm / 2.8 in

TRAVEL MAP WEEKEND WORLD



IT IS A COMPACT SCRATCH-OFF MAP OF YOUR TRAVELS AND A TRUE ASSISTANT IN ANY TRIP. THE MAP FEATURES A LIST OF 15 FUN TRAVEL MUST-HAVE THINGS THAT NEED TO BE TAKEN ON A TRIP, AN ENLARGED MAP OF EUROPE AND A QUEST ON THE TUBE, WHICH WILL ADD EMOTIONS AND MEMORIES IN ANY OF YOUR TOURS.

MINI MAP OF THE WORLD AND MAP OF EUROPE 2 IN 1



BEFORE



AFTER



ACCESSORY SET

- instruction



SKU: WW
EAN: 4820191130241

40 cm / 15.7 in



60 cm / 23.6 in

POSTER

W 60 cm / 23.6 in
H 40 cm / 15.7 in

PAPER

ENG



TUBE

H 45 cm / 17.7 in
D 7 cm / 2.8 in

TRAVEL MAP USA BLACK

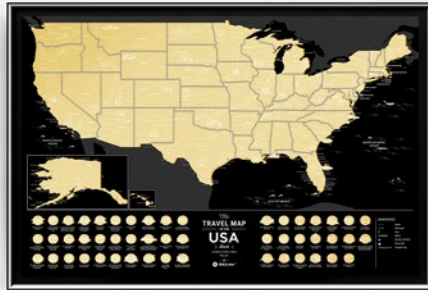

THIS SCRATCH-OFF MAP HAS BEEN DESIGNED FOR PERSONAL JOURNEYS IN US. SCRATCH OFF THE SPECIAL LAYER FROM THE STATES YOU'VE VISITED AND CREATE YOUR OWN STORY OF ADVENTURES!

DETAILED MAP OF THE USA
AND 50 SIGHTS

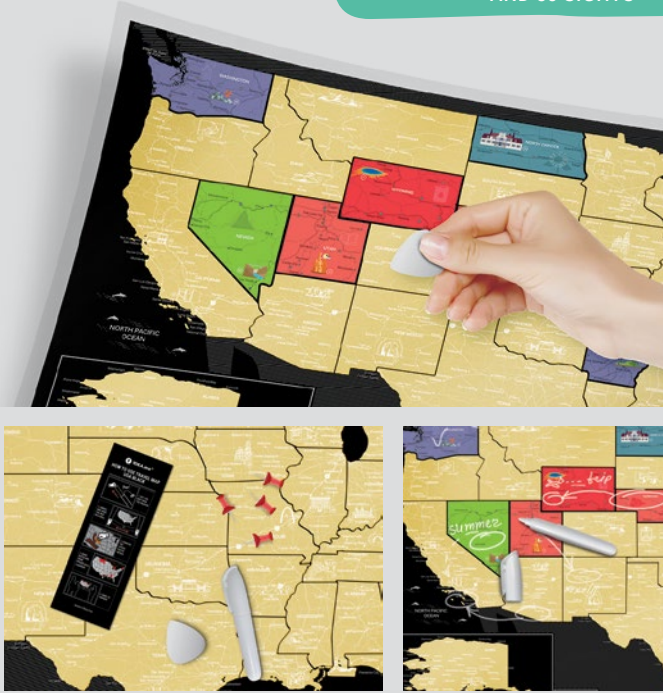

ACCESSORY SET

- instruction
- scratcher
- white ink marker
- pins



SKU: USAB
EAN: 4820191130289

BEFORE



AFTER

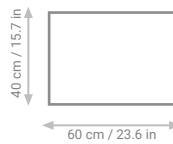

POSTER

W 60 cm / 23.6 in
H 40 cm / 15.7 in

PLASTIC

ENG



TUBE

H 45 cm / 17.7 in
D 7 cm / 2.8 in



IT IS AN ORIGINAL SCRATCH-OFF MAP OF POLAND, DESIGNED IN THE NATIONAL COLORS OF THE COUNTRY. THE MAP SHOWS THE MAIN SYMBOLS OF REGION CITIES, TOURIST DESTINATIONS, AND ALSO THE SIGHTS OF THE COUNTRY.

15 MUST-VISIT ATTRACTIONS



ACCESSORY SET

- instruction
- scratcher
- pins
- felt shred
- stickers



SKU: PL
EAN: 4820191130364

BEFORE



AFTER

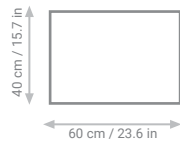

POSTER

W 60 cm / 23.6 in
H 40 cm / 15.7 in

PAPER

PL

TUBE

H 45 cm / 17.7 in
D 7 cm / 2.8 in



THIS MAP HAS BEEN DESIGNED TO SHOW WHERE YOU CAN TRAVEL THROUGH BRAZIL. THE MAP CONTAINS ISLANDS, CITIES, REGIONS AND THE MAIN POPULAR DESTINATIONS OF BRAZIL. IT IS AN EXCELLENT DECOR FOR HOME AND ALSO AN INSPIRING PRESENT FOR YOUR FRIENDS AND FAMILY.

29 MUST-VISIT ATTRACTIONS



ACCESSORY SET

- instruction
- scratcher
- white ink marker
- pins
- felt shred
- stickers



SKU: BR
EAN: 4820191130395

BEFORE



AFTER

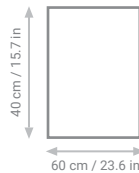

POSTER
W 40 cm / 15.7 in
H 60 cm / 23.6 in

PLASTIC

PT

TUBE
H 45 cm / 17.7 in
D 7 cm / 2.8 in

TRAVEL MAP ČESKÁ REPUBLIKA



IT IS AN ORIGINAL SCRATCH-OFF TRAVEL MAP OF CZECH REPUBLIC WHICH WILL INSPIRE YOU TO LEARN MORE ABOUT THIS PICTURESQUE COUNTRY AND EXPLORE EVERY WONDERFUL VIEW. THE MAP SHOWS MAIN TOURIST DESTINATIONS AND VARIOUS SIGHTS. THE MAP IS AN EXCELLENT DECOR AND AN ORIGINAL GIFT.

24 MUST-VISIT ATTRACTIONS



ACCESSORY SET

- instruction
- scratcher
- pins
- felt shred
- stickers



SKU: CZ
EAN: 4820191130586

BEFORE



AFTER

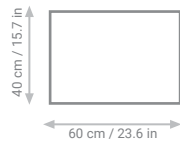

POSTER
W 60 cm / 23.6 in
H 40 cm / 15.7 in

TUBE
H 45 cm / 17.7 in
D 7 cm / 2.8 in

TRAVEL MAP MAGNETIC WORLD



IT IS A SOUVENIR MAGNETIC SCRATCH-OFF MAP OF THE WORLD. MAKE UP THE WORLD MAP FROM THE MAGNETIC CONTINENTS AND SCRATCH OFF THE GOLDEN LAYER FROM THE COUNTRIES YOU'VE VISITED. EMBELLISH A FRIDGE AT HOME OR A BOARD IN AN OFFICE WITH THE STYLISH DECOR.

MAGNETIC FRIDGE MAP



ACCESSORY SET

- 14 magnets
- card "Map legend"



SKU: MG
EAN: 4820191130609

BEFORE



AFTER



MAP

PLASTIC



ENG

BOX

W 24,6 cm / 9.7 in
H 32,4 cm / 12.8 in

NEW

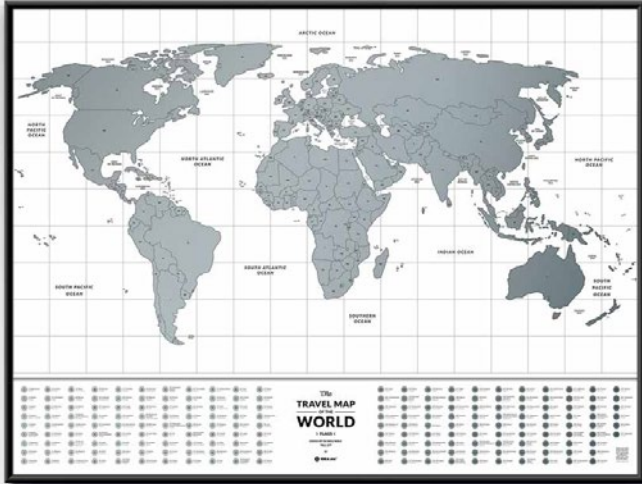

THE TRAVEL MAP FLAGS WORLD IS A SCRATCH-OFF MAP WITH NATIONAL FLAG CHECK-LIST. USE A STICKER SET OF THE NATIONAL FLAGS, MARK FAVORITE PLACES, AND PLAN YOUR TRIP. ERASE THE SILVER SCRATCH-OFF LAYER FROM THE PLACES YOU'VE BEEN TO AND REVEAL THE COLORFUL BACKGROUND OF THE FLAGS CHECK-LIST. THE MAP WILL BECOME AN INSPIRING GIFT AND A STYLISH DECOR.

ERASE THE SCRATCH-OFF LAYER AND USE A STICKER SET OF THE NATIONAL FLAGS



ACCESSORY SET

- instruction
- scratcher
- pins
- felt shred
- stickers



SKU: FW
EAN: 4820191130883

BEFORE



AFTER

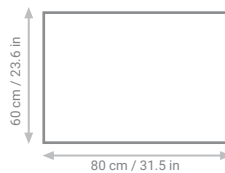

POSTER

W 80 cm / 31.5 in
H 60 cm / 23.6 in

PAPER

ENG

TUBE

H 64 cm / 25.2 in
D 7 cm / 2.8 in



THE KIDS MAP WORLD IS A MAGNETIC WORLD MAP WITH AUGMENTED REALITY FOR KIDS. REVIVE 40 ANIMALS WITH THE HELP OF A FREE AR APPLICATION AND LEARN THE NAMES OF ANIMALS. STUDY CONTINENTS AND OCEANS ON THE MAP AND PLAY WITH COLORFUL MAGNETS. TEACH YOUR CHILD IN AN INTERESTING AND EXCITING WAY AND SPEND TIME WITH THE GAIN. DISCOVER THE WHOLE WORLD BY PLAYING!

24 MUST-VISIT ATTRACTIONS



ACCESSORY SET

- 40 magnets
- AR application



SKU: KMW

BEFORE



AFTER

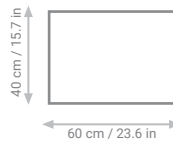

POSTER

W 60 cm / 23.6 in
H 40 cm / 15.7 in





BUCKET LIST

Life edition

WOULD YOU LIKE TO GET NEW EMOTIONS AND IMPRESSIONS? DO YOU NEED MOTIVATION AND INSPIRATION? QUICKLY OPEN THE TUBES, GET THEM OUT OF THE BOX AND TAKE THEM TO THE FULLEST!

2. SCRATCH OFF THE TOP FOIL LAYER

BUCKET LIST

Life edition

EASY LEVEL
PAINT A PICTURE

GIVE 50 THANKS TO 50 DIFFERENT PEOPLE

CHANGE YOUR HAIRSTYLE

TAKE PART IN A QUIZ

SPEND 2 WEEKS WITH YOUR PHONE OFF

READ A BOOK IN A DAY

BUILD A SNOWMAN

PLUNGE INTO AN ICE HOLE

VISIT 3 CITIES IN 1 MONTH

SKIP WORK

EAT NO MEAT FOR A WEEK

LAUNCH A SKY LANTERN

HAVE A NIDE LATE-NIGHT SWIM

WIN A BOARD OF LOTTERY TICKET
736421

DONATE HALF OF YOUR SALARY TO A CHARITY

TAKE A PHOTO WITH SANTA CLAUS

SPEND WEEKEND IN A TENT

GO SKIING (OR SNOWBOARDING)

GALLOP ON A HORSE

PARTICIPATE IN A GIVING TREE

MEDIUM LEVEL

CREATE A TRADITION WITH FAMILY AND FRIENDS
12/24

GIVE AN INTERVIEW TO MASS MEDIA

RIDE A HIGH-SPEED TRAIN

WALK A MILE IN 1 DAY

CLIMB A VOLCANO

DRINK COFFEE WITH A CELEBRITY

THROW A SURPRISE PARTY FOR A FRIEND

~~YESTERDAY~~
NO
~~TOMORROW~~

#100BUCKETLIST

SCRATCH-OFF POSTERS

YOU CAN!

#100BUCKETLIST - scratch-off gift posters with lifetime to-do lists. On the posters, there are interesting motivational tasks for anyone.

Mark the completed task by scratching off the special layer, and set new goals for yourself. The collection of the scratch-off posters #100BUCKETLIST has gained popularity and appreciation among the clients with its wide variety of products for all ages and interests. Such a motivational gift for family, friends, kids and co-workers will be an amazing decor for home and office.



A SCRATCH-OFF MOTIVATIONAL POSTER WITH A HUNDRED OF TO-DO TASKS IS DESIGNED FOR COLORING YOUR LIFE. CHOOSE A TASK, GAIN STRENGTH AND GO AHEAD! SCRATCH OFF THE SPECIAL LAYER AND TAKE YOUR HONORARY BADGE.

MOTIVATIONAL TO-DO LIST
FOR EVERYONE



ACCESSORY SET

- instruction
- scratcher
- pins
- felt shred
- stickers



SKU: 100Den
EAN: 4820191130173

BEFORE



AFTER

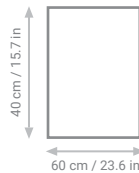

POSTER
W 40 cm / 15.7 in
H 60 cm / 23.6 in

PAPER

ENG

TUBE
H 45 cm / 17.7 in
D 7 cm / 2.8 in

#100BUCKETLIST®
SCRATCH-OFF POSTERS

#100BUCKETLIST LOVE EDITION

NEW



A SCRATCH-OFF MOTIVATIONAL POSTER
FOR A COUPLE WITH THE MOST ROMANTIC, ACTIVE
AND EXCITING TASKS WHICH BLAZES UP TENDER PASSION
AND DRAWS YOU TOGETHER.

ROMANTIC TO-DO LIST
FOR A COUPLE



ACCESSORY SET

- instruction
- pins
- scratcher
- felt shred
- trinket
- stickers



SKU: 100Len
EAN: 4820191130180

BEFORE



AFTER

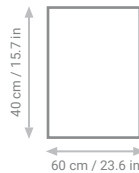

POSTER
W 40 cm / 15.7 in
H 60 cm / 23.6 in

PAPER
ENG

TUBE
H 45 cm / 17.7 in
D 7 cm / 2.8 in



#100BUCKETLIST®
SCRATCH-OFF POSTERS

**#100BUCKETLIST KAMASUTRA
EDITION**



A SCRATCH-OFF MOTIVATIONAL POSTER
WITH THE MOST PIQUANT AND SEDUCTIVE KAMASUTRA POSITIONS.
GRAB YOUR PARTNER, QUICKLY ERASE THE SPECIAL LAYER
AND MAKE THE SCRATCHED POSE TO BE ALL
THAT CAN BE DESIRED.

PIQUANT TO-DO LIST
FOR A COUPLE



ACCESSORY SET

- instruction
- scratcher
- pins
- felt shred



SKU: 100K
EAN: 4820191130159

BEFORE



AFTER



40 cm / 15.7 in



POSTER

W 40 cm / 15.7 in
H 60 cm / 23.6 in

PAPER

ENG



TUBE

H 45 cm / 17.7 in
D 7 cm / 2.8 in



A SCRATCH-OFF EDUCATIONAL POSTER FOR KIDS CONSISTS OF A HUNDRED OF THE MOST FASCINATING AND INTERESTING TASKS. IT IMMEDIATELY INSPIRES YOUR CHILD TO DREAM, TO LEARN SOMETHING NEW AND TO MAKE THEIR FIRST UNFORGETTABLE ACHIEVEMENTS.

EDUCATIONAL TO-DO LIST
FOR A CHILD



ACCESSORY SET

- instruction
- sticker for personalization
- "Adult treaty"
- "Greetings from childhood"
- scratcher



SKU: 100Jen
EAN: 4820191130166

BEFORE

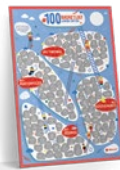

AFTER

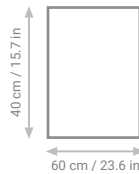

POSTER
W 40 cm / 15.7 in
H 60 cm / 23.6 in

PAPER

ENG

TUBE
H 45 cm / 17.7 in
D 7 cm / 2.8 in

#100BUCKETLIST®
SCRATCH-OFF POSTERS

#100BUCKETLIST WONDERS
EDITION

NEW



EVERYBODY'S HEARD ABOUT NEW 7 WONDERS OF THE WORLD. BUT FEW ARE FAMILIAR WITH OTHER AMAZING SIGHTS. THAT IS WHY OUR TEAM HAS CREATED A UNIQUE LIST OF 100 WONDERS OF THE WORLD THAT YOU MUST SEE. ERASE THE SCRATCH-OFF LAYER FROM THE SIGHTS YOU'VE VISITED AND COLLECT THE EMOTIONS.

EDUCATIONAL TO-DO LIST
FOR A CHILD



ACCESSORY SET

- scratcher
- pins
- felt shred



SKU: 100W
EAN: 4820191130876

BEFORE



AFTER

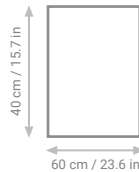

POSTER
W 40 cm / 15.7 in
H 60 cm / 23.6 in

PAPER

ENG

TUBE
H 45 cm / 17.7 in
D 7 cm / 2.8 in

1. ДИСТАНЦИЯ КАРТЫ НА ТЫСЯЧА

2. ПАЗЕЛИКИ И ПОДСВЕТКА КАРТЫ НА СТЕНЫ

3. ДИЕН ИДУМАК ИНТЕРЕСНЫЕ ФАКТЫ О КОСМОСЕ И ЗАРЯЖЕНАЯ КАРТА ГОРНОМОНИМ

Медведица

The STAR MAP of the SKY

by 1DEA.me®

ЭТА СВЕЯЩАЯСЯ КАРТА ЗВЕЗДНОГО НЕБА, КОТОРАЯ ВЕРИТЕЛЬНО ИНТЕРЕСНЫХ ФАКТОВ О КОСМОСЕ, СОЛНЕЧНОЙ СИСТЕМЫ И ПЛАНЕТАМ, ТОЛЬКО ПРЕДСТАВИТЬ ТЫ ВЫКЛОУИШЬ СВЕТА ИБЕЗЪЕДЬ И СВЕТИТЬСЯ СОЗВЕЗДИЯ, ЗНАКИ ЗОДИАКА И ДРУГИЕ ЗВЕЗДЫ. КАРТА ЗВЕЗДНОГО НЕБА — ЭТО ЕЩЕ И ОРИГИНАЛЬНЫЙ СРЕДСТВО ПРИВЛЕКАТЬ ВНИМАНИЕ ВСЕХ ТВОИХ ЗНАКОМЫХ И ПРИБЛИЖАЮЩИЙ ПОДАРОК, О КОТОРОМ, НАВЕРНЯКА, МЕЛТАЕТ КАКИМ-ТО

THIS GLOWING SKY MAP, WHICH IS SURE TO CAPTIVATE YOU AND ATTRACT ALL YOUR FRIENDS AND FAMILY, AS WELL AS PRESENT, WHICH PROBABLY EVERYONE DREAMS OF.

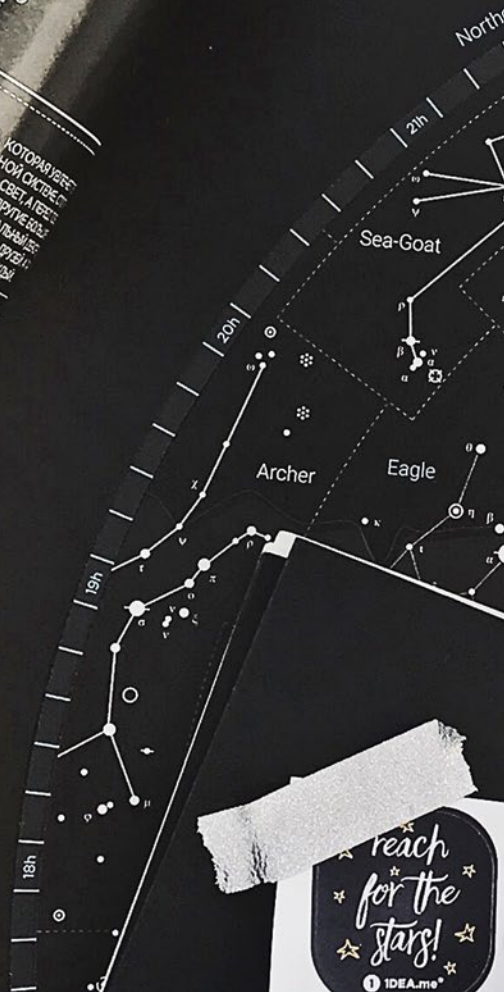
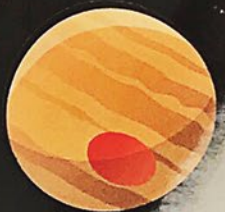

reach for the stars!

1DEA.me®



OTHER PRODUCTS

INSPIRING GIFTS

Every day we create design presents which gain love of many people from different countries!

In this section you will find new ideas that we have incorporated in remarkable inspiring gifts for family, kids and friends.



OTHER
PRODUCTS

STAR MAP OF THE SKY

NEW

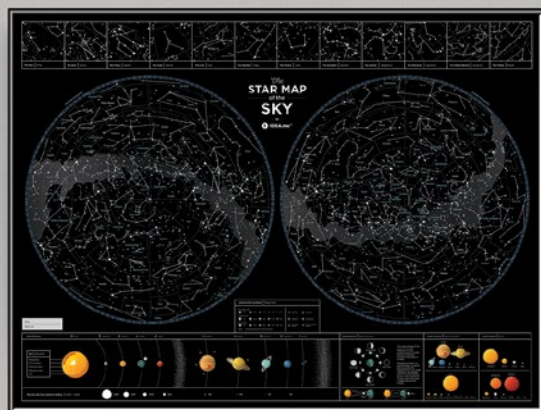

STAR MAP OF THE SKY IS A WONDERFUL OPPORTUNITY TO MAKE A MAGIC PRESENT OF THE WHOLE STARScape IN ONE GIFT. IT'S A DESIGN GLOW-IN-THE-DARK MAP OF A NIGHT SKY. STUDYING THE SPACE IS SO INTERESTING AND EXCITING BECAUSE IT IS SO MYSTERIOUS

GLOW IN THE DARK

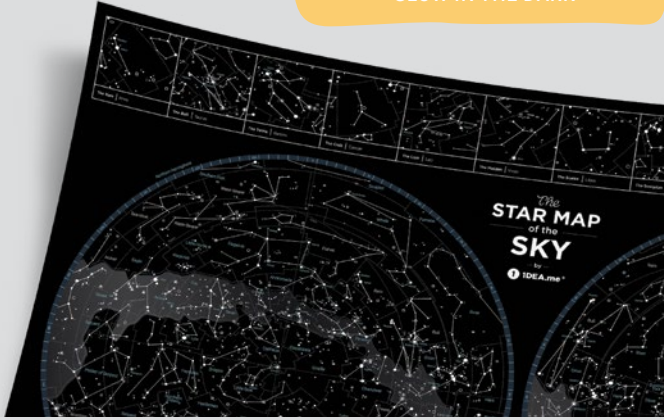

DAY

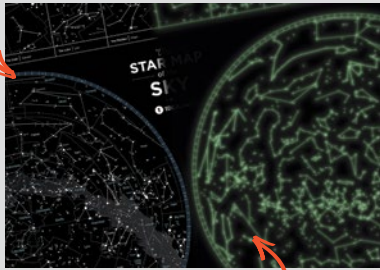

NIGHT



ACCESSORY SET

- instruction
- stickers



SKU: SMSen
 EAN: 4820191130333

DAY



NIGHT

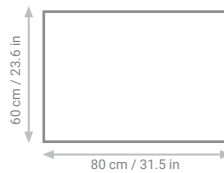
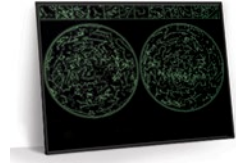

POSTER

W 80 cm / 31.5 in
 H 60 cm / 23.6 in

PAPER

ENG

TUBE

H 64 cm / 25.2 in
 D 7 cm / 2.8 in



OTHER
PRODUCTS

"SPACE ADVENTURES"
SCRATCH-OFF WALL GROWTH CHART

NEW



IT IS A SET FOR BOYS' DEVELOPMENT WHICH TURNS THE USUAL GROWTH MEASUREMENTS INTO A GAME. PLAYING WITH THE SPACE DETAILS, A BOY WILL LEARN THE NAMES OF THE PLANETS AND INTERESTING FACTS ABOUT THEM. IT IS AN AMAZING DECOR FOR A KID'S ROOM AND A WONDERFUL GIFT.

INTERACTIVE SCRATCH-OFF WALL GROWTH CHART



ACCESSORY SET

- set of bright details
- stickers
- glue dots
- educational card



SKU: RBen
EAN: 4820191130623

BEFORE



AFTER



90 cm / 35.4 in

5 cm / 1.97 in

LINE

W 5 cm / 1.97 in
H 60 cm / 23.6 in

PLASTIC

ENG

BOX

W 16.3 cm / 6.4 in
H 22.5 cm / 8.9 in

OTHER
PRODUCTS

"MAGIC ADVENTURES"
SCRATCH-OFF WALL GROWTH CHART

NEW



IT IS A SET FOR GIRLS' DEVELOPMENT WHICH TURNS THE USUAL GROWTH MEASUREMENTS INTO A GAME. PLAYING WITH THE BRIGHT PARTS, A GIRL WILL LEARN THE NAMES OF THE CONTINENTS AND INTERESTING FACTS ABOUT BIRDS WHICH LIVE THERE. IT IS AN AMAZING DECOR FOR A KID'S ROOM AND A WONDERFUL GIFT.

INTERACTIVE SCRATCH-OFF WALL GROWTH CHART



ACCESSORY SET

- set of bright details
- stickers
- glue dots
- educational card



ERASE THE SCRATCH



MAKE NOTES WITH A MARKER



USE THE STICKERS

SKU: RGen
EAN: 4820191130616

BEFORE



AFTER



90 cm / 35.4 in

5 cm / 1.97 in

LINE

W 5 cm / 1.97 in
H 60 cm / 23.6 in

PLASTIC

ENG

BOX

W 16.3 cm / 6.4 in
H 22.5 cm / 8.9 in

CORPORATE PRESENT



SPOTS WHERE YOU CAN PLACE YOUR LOGO



PLACE YOUR LOGO ON ANY OF 1DEA.me PRODUCTS

PRINT MOQ
PRODUCTION PERIOD
PRODUCTS
LANGUAGES
MAPS/POSTERS SIZES
MATERIAL
PACKING
LOGO LAYING ON

30 pcs
21 business days
scratch-off travel maps, scratch-off posters, tube
English, Russian, Ukrainian
A1, A2
plastic, paper
tube
direct printing/stickers

INDIVIDUAL PROJECT



**TOGETHER WITH OUR TEAM, DEVELOP
A UNIQUE GIFT WITH AN INDIVIDUAL DESIGN**

PRINT MOQ
PRODUCTION PERIOD
PRODUCTS
LANGUAGES
MAPS/POSTERS SIZES
MATERIAL
PACKING
INSIDE

500 pcs
3 months
scratch-off travel maps, scratch-off posters
English or local
A1, A2
plastic, paper
tube
accessory set

STANDS



**WOODEN STAND
FOR 35 TUBES**



**CARTON STAND
FOR 12 TUBES**

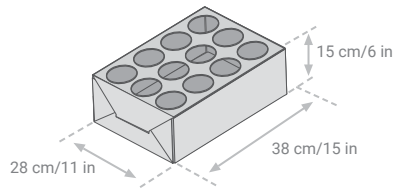
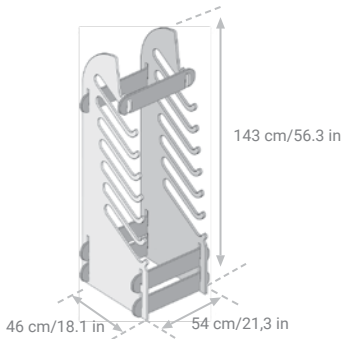



The TRAVEL MAP OF THE WORLD HOLIDAY <

IDEA.me

5 travel ideas

RAPSI

DOCRAN

THE YOUR TRAVEL JOURNALS

LARGE TRANSPARENT SCRATCH-OFF MAP

The TRAVEL MAP OF THE WORLD

air

DISCOVER THE WHOLE WORLD

IDEA.me



**DREAM
PLAN
DO**

www.1dea.me
sales@1dea.me

 /1DEAme  1dea.me_worldwide